

VALVES FOR WINCHES

MBDN-500-AMSF

**DOUBLE ACTING
WITH BRAKE RELEASE**

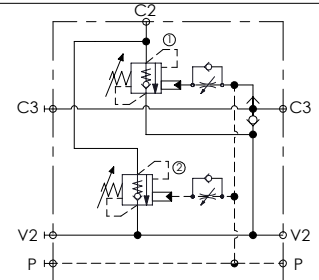
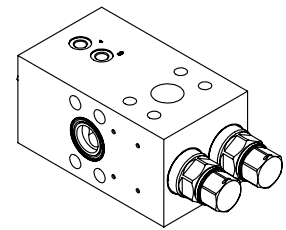
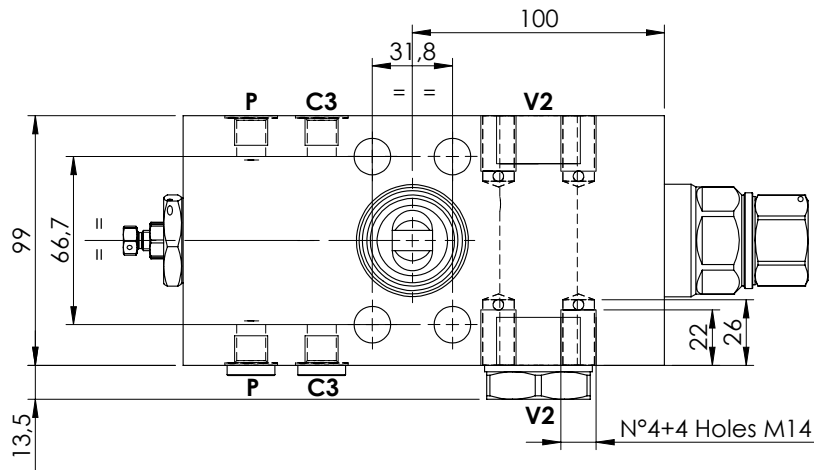
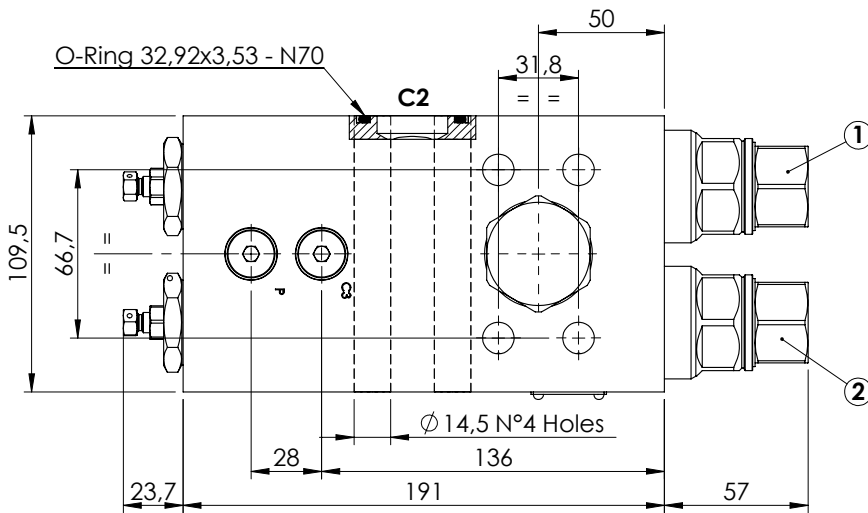

SPECIFICATIONS

Max. operating pressure:	500 bar
Rated flow:	500 l/min
Manifold:	Steel
Weight:	15,18 kg

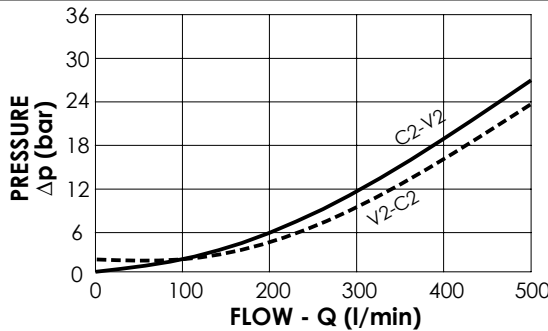

NOTES

Setting: at least 1.3 times the load induced pressure

ORDERING CODES

Quick code	Description	Pilot ratio	Main ports size	Standard setting (bar, Q=5 l/min)	Adjust. range (bar)	Pressure increase (bar/turn)
MB000676	MBDN-500-AMSF-13-S11-N500	13:1	C2,V2: 1-1/4" SAE 6000 P,E,C3: G 1/4"	500	250-500	104