

RELIEF VALVE

CPLN-250-DHGD

DIFFERENTIAL AREA
POPPET TYPE

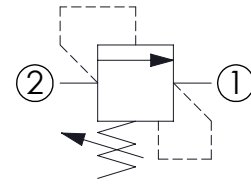
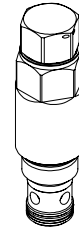
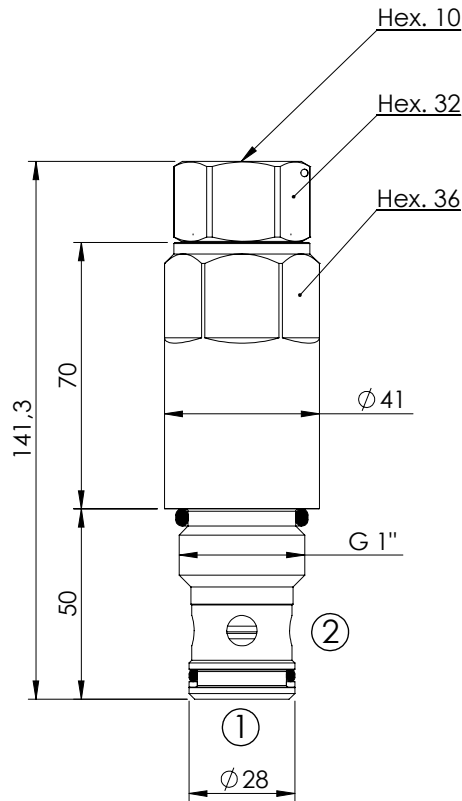

SPECIFICATIONS

Max. operating pressure:	350 bar
Rated flow:	250 l/min
Cavity:	VP000154
Weight:	0,9 kg

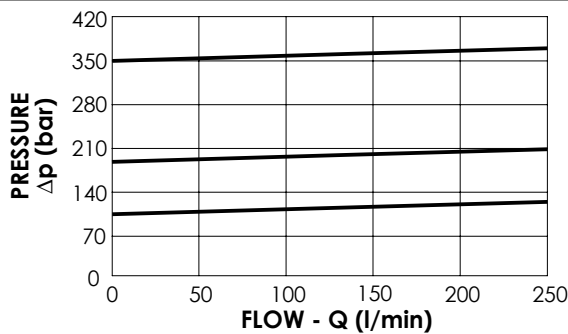

NOTES

Installation torque:	230 - 280 Nm
Seal kit:	RC900154

ORDERING CODES

Quick code	Description	Standard setting (bar, Q=5 l/min)	Adjustment range (bar)	Pressure increase (bar/turn)
CP000046	CPLN-250-DHGD-HN-154-N350	350	120-350	65
CP000119	CPLN-250-DHGD-HN-154-N200	200	50-200	38
CP000224	CPLN-250-DHGD-HN-154-N100	100	20-100	19