

LOGIC ELEMENT

CDLN-100-SCPD

**NORMALLY CLOSED
SPOOL TYPE
WITH INTERNAL ORIFICE**

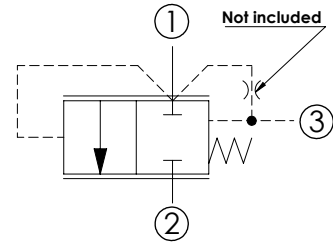
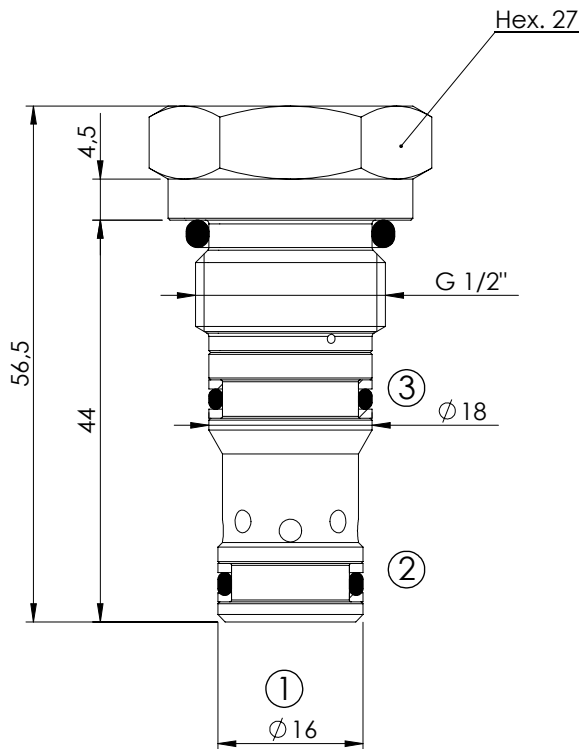
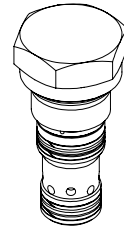

SPECIFICATIONS

Max. operating pressure:	350 bar
Rated flow:	100 l/min
Cavity:	VP000198
Weight:	0,12 kg
Spool:	Ø10 mm
Internal orifice:	M5 thread

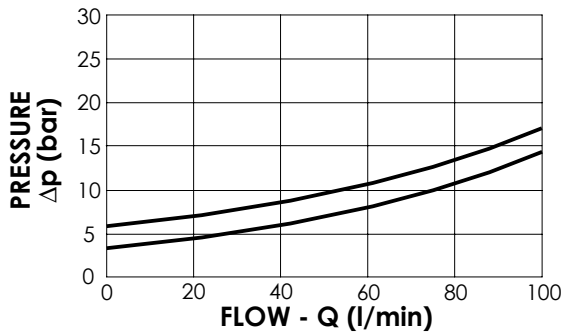

NOTES

Installation torque:	75 - 85 Nm
Seal kit:	RD700198
Parts in body compensator	

ORDERING CODES

Quick code	Description	Cracking pressure (bar)	
CD000216	CDLN-100-SCPD-13-198-N003	3	
CD000215	CDLN-100-SCPD-13-198-N006	6	
CD000220	CDLN-100-SCPD-13-198-N012	12	
CD000238	CDLN-100-SCPD-13-198-N016	16	