

FLOW REGULATOR

MFPT-100-MHAR

PRESSURE COMPENSATED PRIORITY FLOW REGULATOR FOR AUXILIARY CIRCUITS

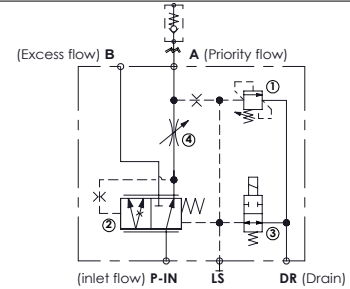
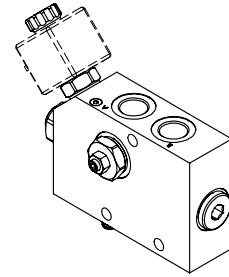
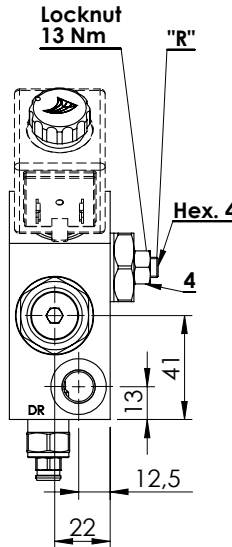
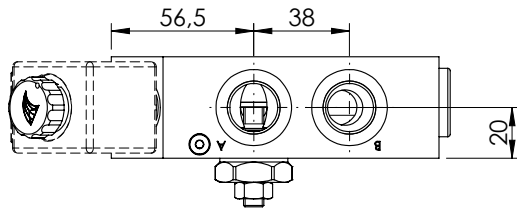
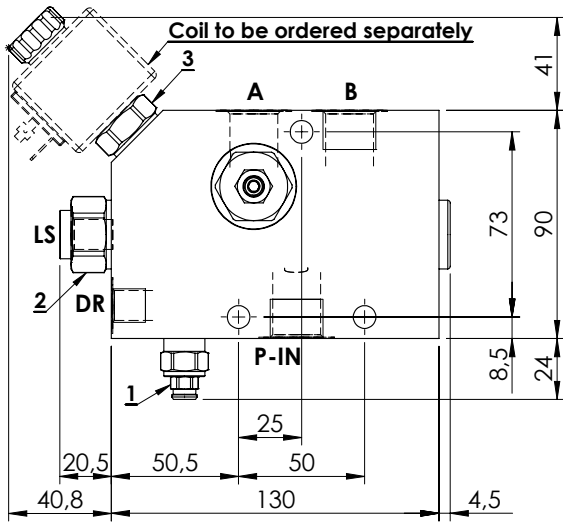
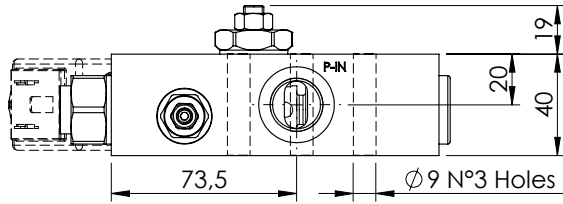

SPECIFICATIONS

Max. operating pressure:	350 bar
Rated flow:	100 l/min
Regulated Flow:	1,5 - 85 l/min
Manifold:	Zinc plated steel
Weight:	3,4 kg
Coil:	M7

NOTES

- Turn screw "R" anti-clockwise to increase regulated flow.
- Drain flow when de-energized 2 l/min.
- Max back pressure admitted on "DR" line 1,5 bar.
- For correct operation 8-9 bar must be present in port A. For open centre or low pressure systems a 9 bar check valve should be fitted in port A.
- Spool switching can be influenced by flexing or stressing the valve body. It is recommended to fit spacers on the mounting bolts between the valve and the mounting surface.
- See chapter four for suitable check valves.

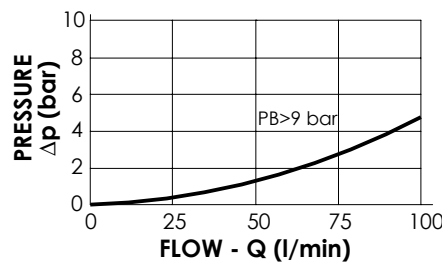
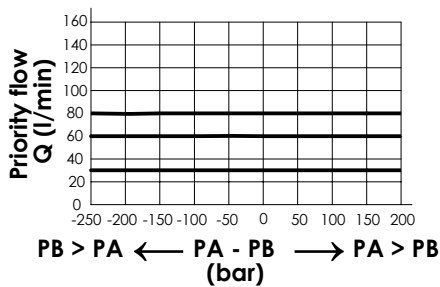

ORDERING CODES

Quick code	Description	Main ports size	Setting range (bar)	Standard setting (bar)	Adjustment (bar/turn)
MF000053	MFPT-100-MHAR-85-G12-N210	P-IN, A,B: G 1/2" DR,LS: G 1/4"	100 - 200	200	75
MF000054	MFPT-100-MHAR-85-G12-N350	P-IN, A,B: G 1/2" DR,LS: G 1/4"	150 - 350	350	165