

**DIFFERENTIAL LOCK VALVE**

**MFDT-150-BFAR**

**WITH ELECTRIC BYPASS**

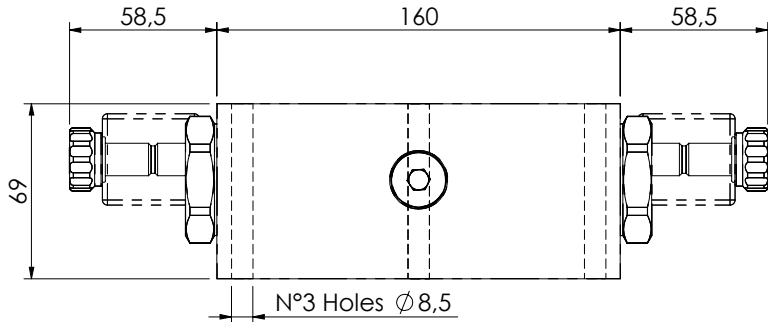

Coil type M7  
not included and  
to be ordered  
separately

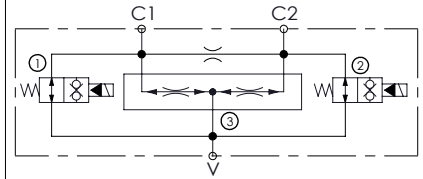
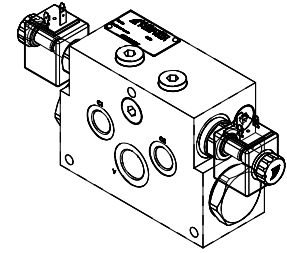
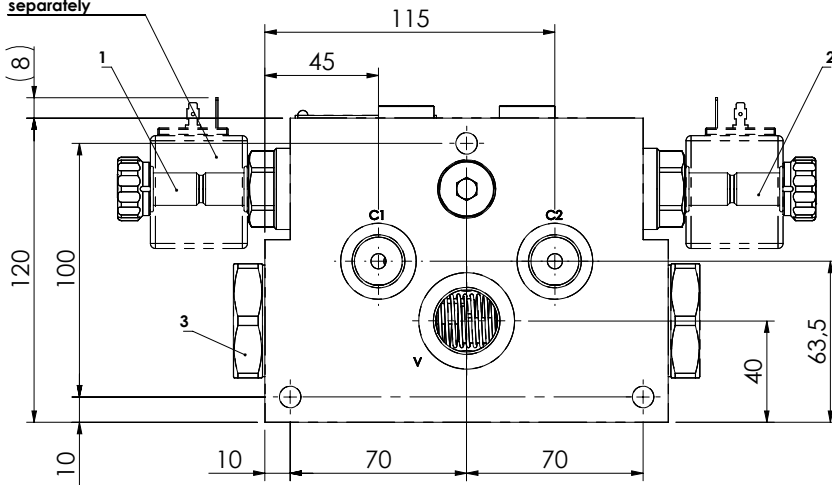

**SPECIFICATIONS**

Max. operating pressure:	350 bar
Rated flow:	150 l/min
Regulated Flow:	See table
Manifold:	Steel
Weight:	9,1 kg
Coil:	M7

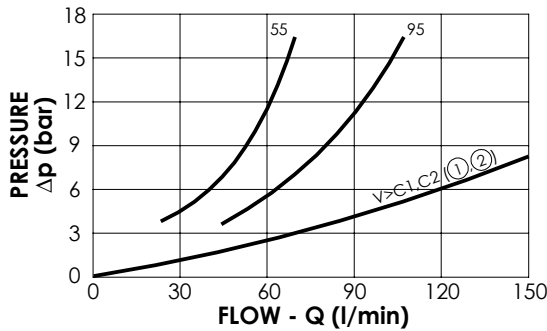

**NOTES**

- For other flow ranges contact AFT sales network.
- See chapter 18.00.000 for coil.

**ORDERING CODES**

Quick code	Description	Main ports size	Regulated flow range (l/min)
MF000347	MFDT-150-BFAR-55-G34-N350	C1,C2: G1/2" V: G3/4"	28-55
MF000348	MFDT-150-BFAR-95-G34-N350	C1,C2: G1/2" V: G3/4"	56-95