

END OF STROKE VALVE

MDTA-060-ABNR

**NORMALLY OPEN
COMPENSATED**

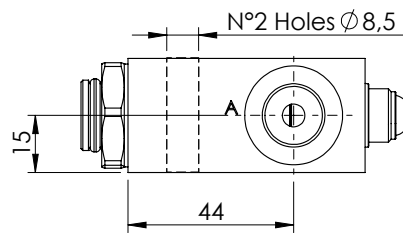
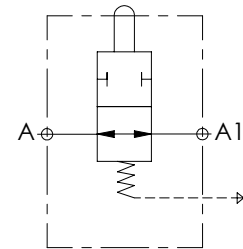
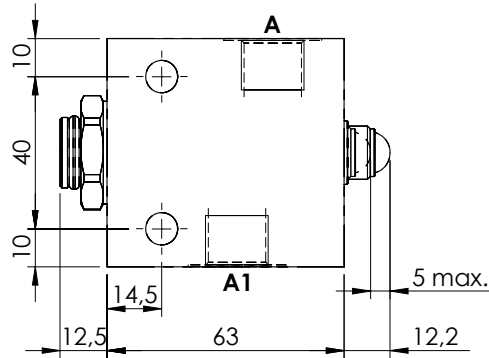
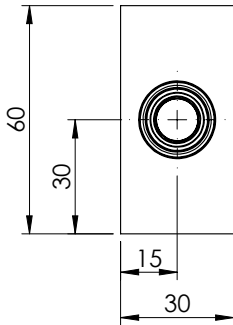
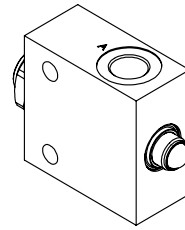
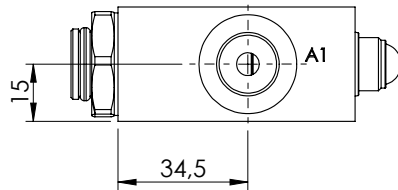

SPECIFICATIONS

Max. operating pressure:	350 bar
Rated flow:	60 l/min
Manifold:	Steel
Weight:	0,82 kg
Maximum stroke:	5 mm
Max. leakage at 150 bar when fully closed:	200 cc/min

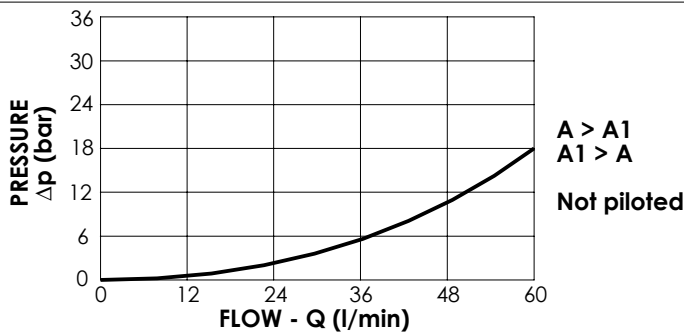

ORDERING CODES

Quick code	Description	Main ports size	Cracking pressure (Kg)	Fully closed (Kg)
MD000043	MDTA-060-ABNR-NP-G38-N350	G 3/8"	4	13