

END OF STROKE VALVE

**MDTC-080-ABNR**

**NORMALLY CLOSED**

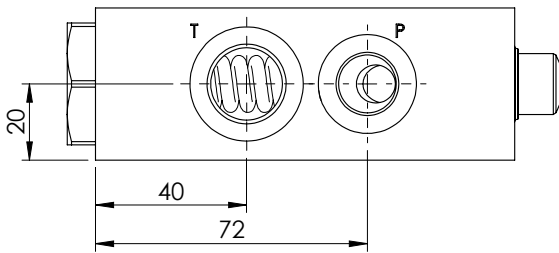
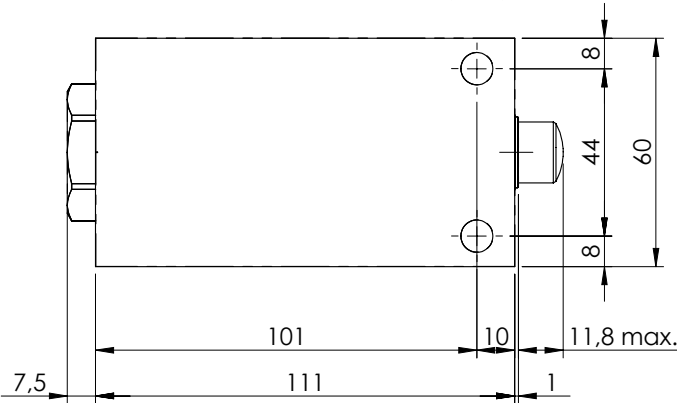
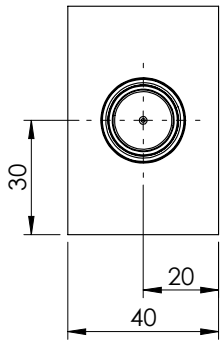
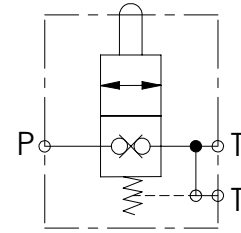
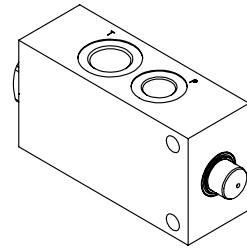
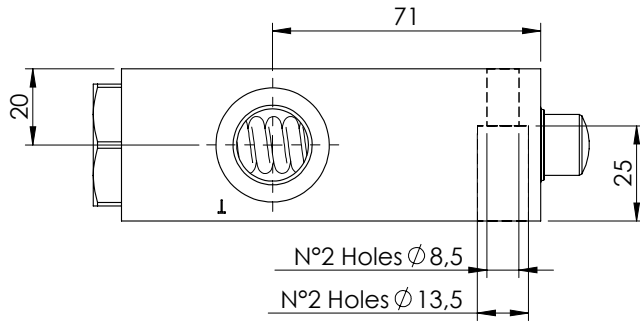

**SPECIFICATIONS**

|                          |          |
|--------------------------|----------|
| Max. operating pressure: | 350 bar  |
| Rated flow:              | 80 l/min |
| Manifold:                | Steel    |
| Weight:                  | 1,71 kg  |
| Maximum stroke:          | 11,8 mm  |

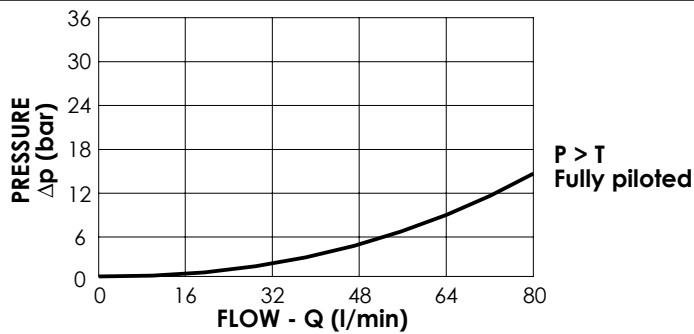

**ORDERING CODES**

| Quick code | Description               | Main ports size        | Cracking pressure (Kg) | Fully open (Kg) |
|------------|---------------------------|------------------------|------------------------|-----------------|
| MD000044   | MDTC-080-ABNR-NP-G38-N350 | P: G 3/8"<br>T: G 1/2" | 36                     | 119             |
|            |                           |                        |                        |                 |
|            |                           |                        |                        |                 |
|            |                           |                        |                        |                 |
|            |                           |                        |                        |                 |
|            |                           |                        |                        |                 |