

**PILOT BLOCK**

**BNND-003-LNQ**

**PROPORTIONAL  
PRESSURE REDUCING  
PILOT MANIFOLD**

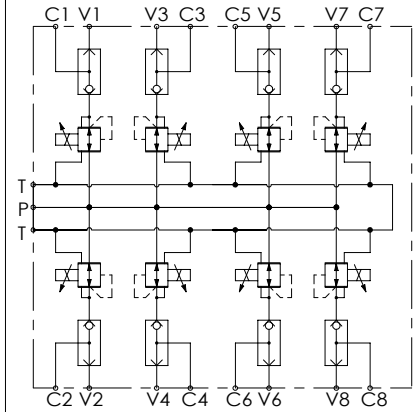
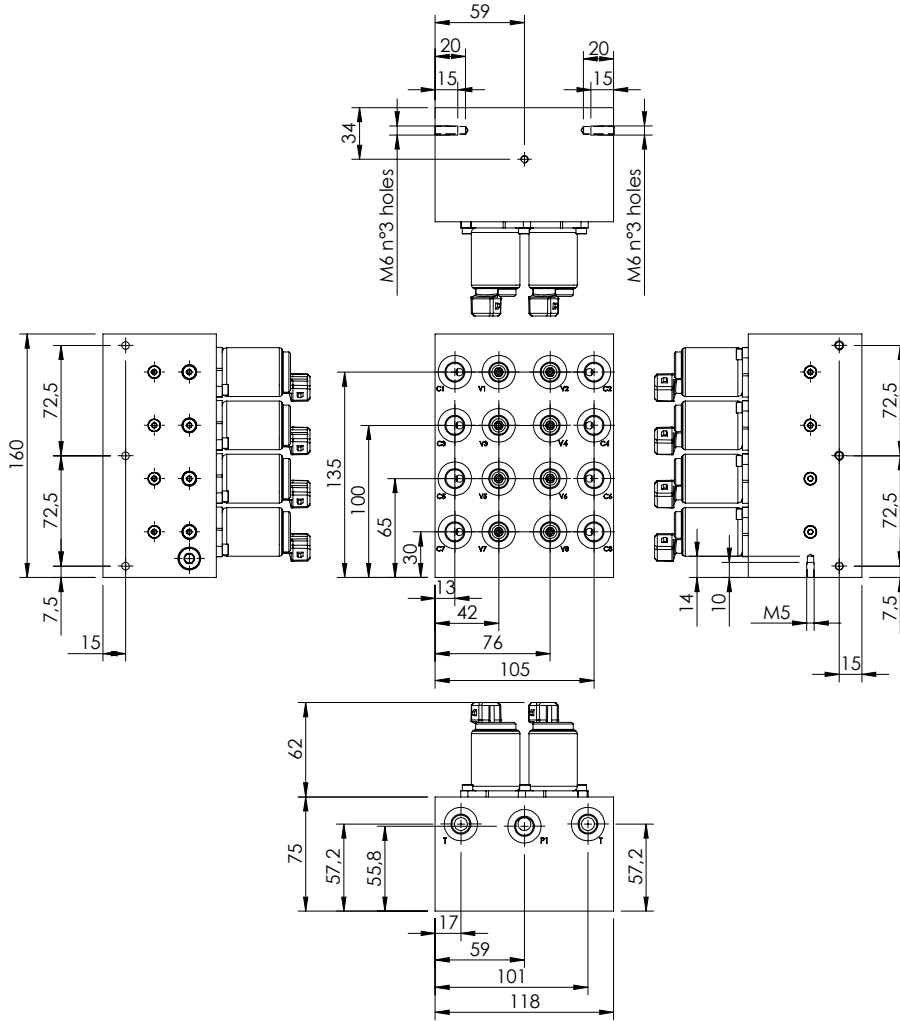
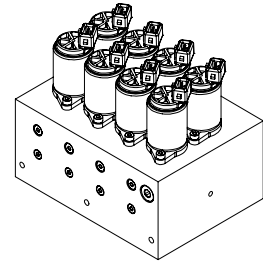

**SPECIFICATIONS**

Max. operating pressure:	50 bar
Rated flow:	3 l/min
Manifold:	Aluminium
Weight:	3,6 kg

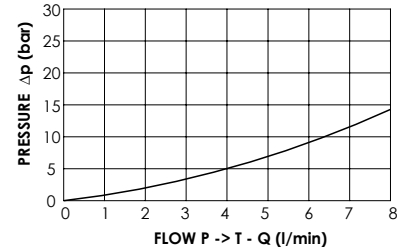
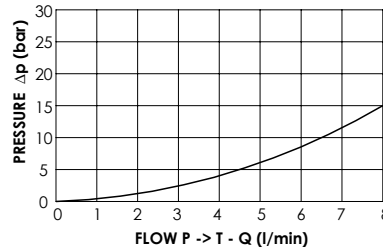
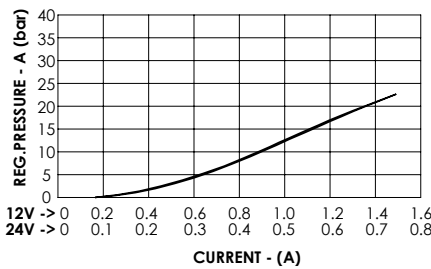

**ORDERING CODES**

Quick code	Description	Main ports size	Regulated pressure range (bar)	Voltage (V)	Connector type
BD000088	BNND-003-LNQ-08-G14-NBAJ	G 1/4"	0-20	24 DC	AMP JUNIOR
BD000201	BNND-003-LNQ-08-G14-NAAJ	G 1/4"	0-20	12 DC	AMP JUNIOR