

SOLENOID OPERATED CARTRIDGE

CEBN-100-NCFN

**PILOT OPERATED
POPPET TYPE**

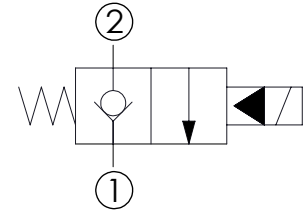
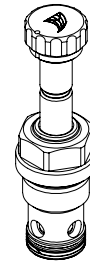
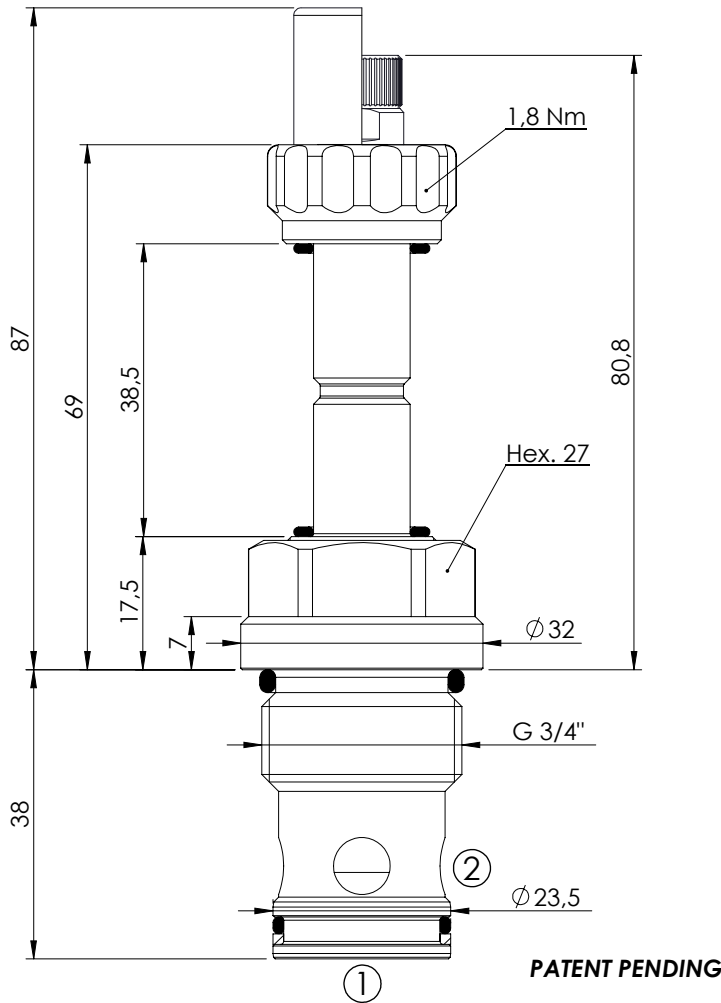

SPECIFICATIONS

Max. operating pressure:	350/500 bar
Rated flow:	100 l/min
Cavity:	VP000057
Weight:	0,25 kg
Min. voltage required:	90% of nominal
Coil type:	M7 type
Seal kit:	RC900057

NOTES

Installation torque: 110 - 130 Nm

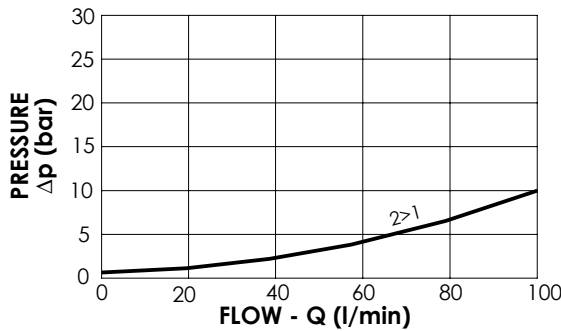

OPTIONS

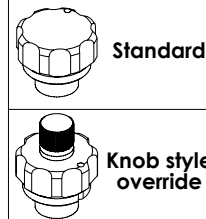

SEALING CAP

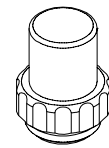

Ordering code:
AT000113

ORDERING CODES

Quick code	Description	Options	Max operating pressure (bar)
CE000280	CEBN-100-NCFN-01-057-N350	Standard	350
CE000282	CEBN-100-NCFK-01-057-N350	Knob style override	350
CE000580	CEBN-100-NCFN-01-057-N500	Standard	500
CE000582	CEBN-100-NCFK-01-057-N500	Knob style override	500