

SOLENOID OPERATED CARTRIDGE

CEBN-300-NCFN

**PILOT OPERATED
POPPET TYPE**

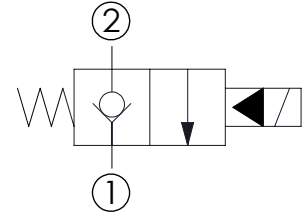
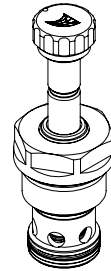
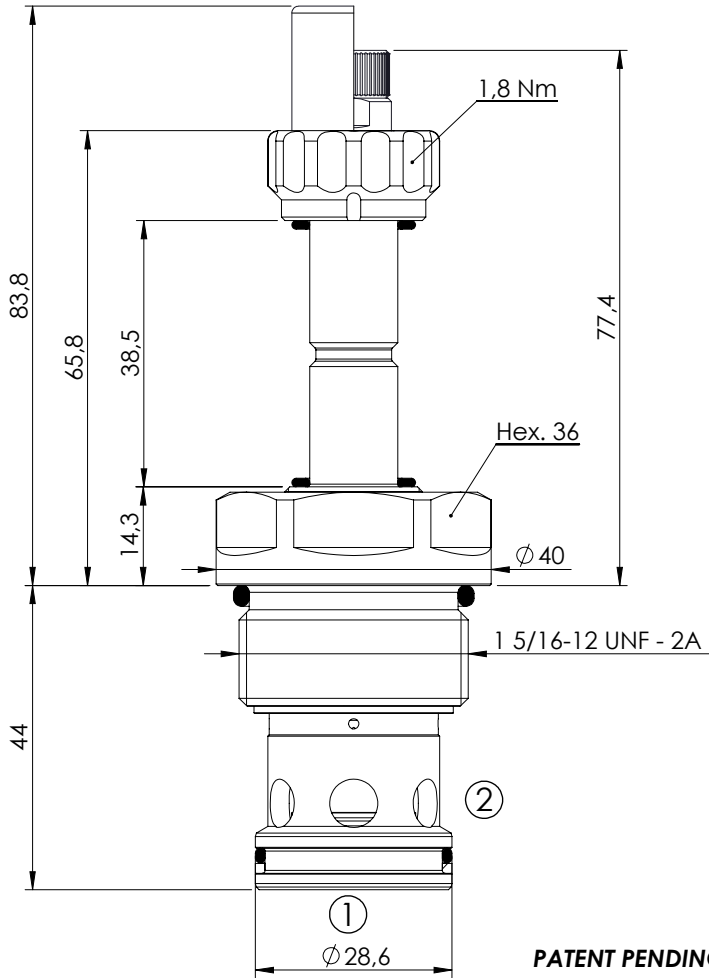

SPECIFICATIONS

Max. operating pressure:	350/500 bar
Rated flow:	300 l/min
Cavity:	SAE-16-2N
Weight:	0,36 kg
Min. voltage required:	90% of nominal
Coil type:	M7 type
Seal kit:	RA900084

NOTES

Installation torque: 118 - 132 Nm

OPTIONS

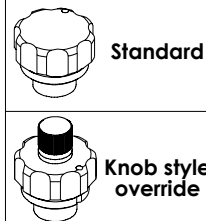

SEALING CAP

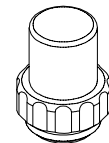

Ordering code:
AT000113

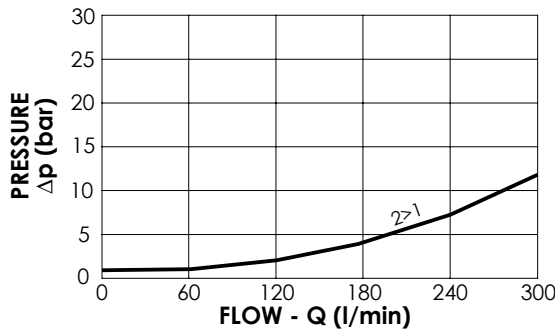

ORDERING CODES

Quick code	Description	Options	Max operating pressure (bar)	
CE000385	CEBN-300-NCFN-01-S16-N350	Standard	350	
CE000387	CEBN-300-NCFK-01-S16-N350	Knob style override	350	
CE000685	CEBN-300-NCFN-01-S16-N500	Standard	500	
CE000687	CEBN-300-NCFK-01-S16-N500	Knob style override	500	