

**SOLENOID OPERATED CARTRIDGE**

**CEBN-100-NAFN**

**PILOT OPERATED  
POPPET TYPE**

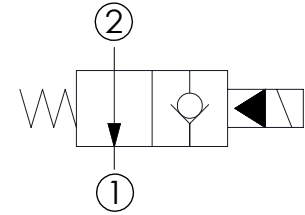
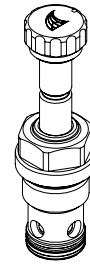
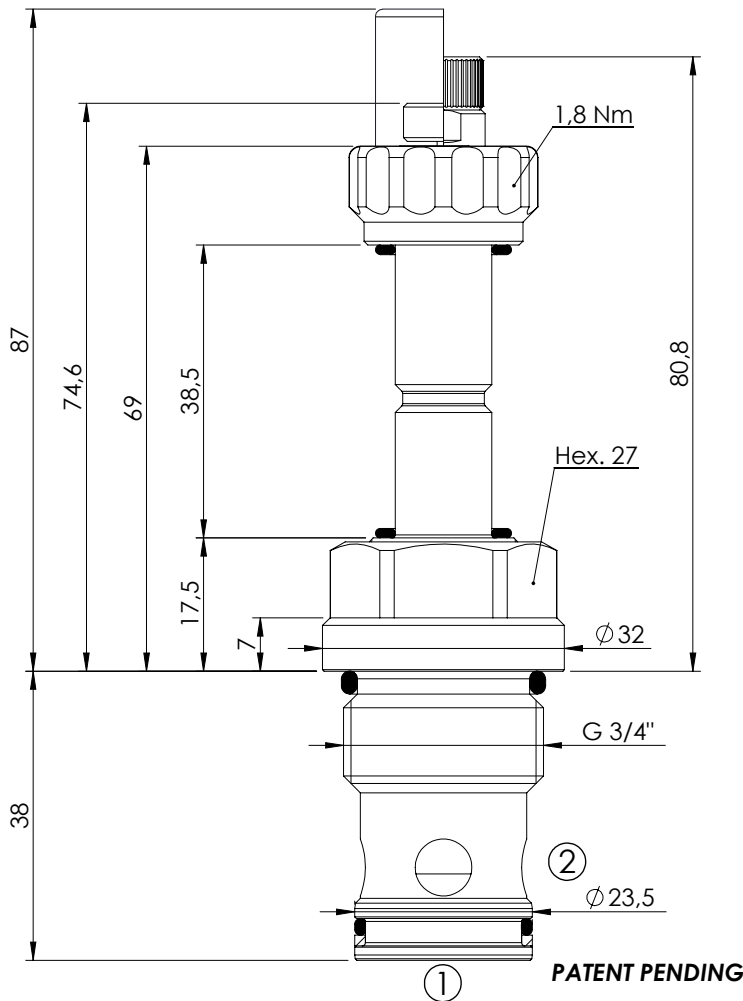

**SPECIFICATIONS**

Max. operating pressure:	350/500 bar
Rated flow:	100 l/min
Cavity:	VP000057
Weight:	0,25 kg
Min. voltage required:	90% of nominal
Coil type:	M7 type
Seal kit:	RC900057

**NOTES**

Installation torque: 110 - 130 Nm

**OPTIONS**

- Standard
- Push style override
- Knob style override

**SEALING CAP**

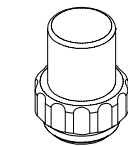

Ordering code:  
AT000113

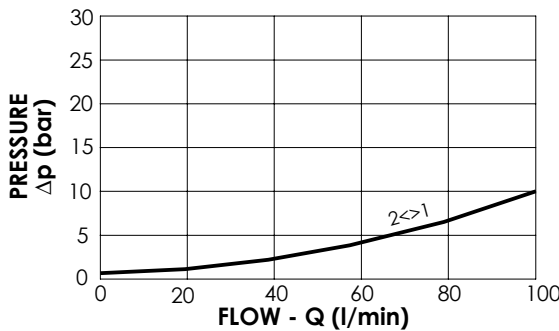

**ORDERING CODES**

Quick code	Description	Options	Max operating pressure (bar)
CE000300	CEBN-100-NAFN-02-057-N350	Standard	350
CE000301	CEBN-100-NAFP-02-057-N350	Push style override	350
CE000302	CEBN-100-NAFK-02-057-N350	Knob style override	350
CE000600	CEBN-100-NAFN-02-057-N500	Standard	500
CE000601	CEBN-100-NAFP-02-057-N500	Push style override	500
CE000602	CEBN-100-NAFK-02-057-N500	Knob style override	500