

**SOLENOID OPERATED CARTRIDGE**

**CEBN-200-NAFN**

**PILOT OPERATED  
POPPET TYPE**

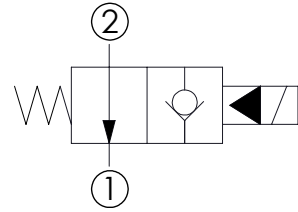
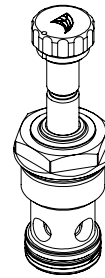
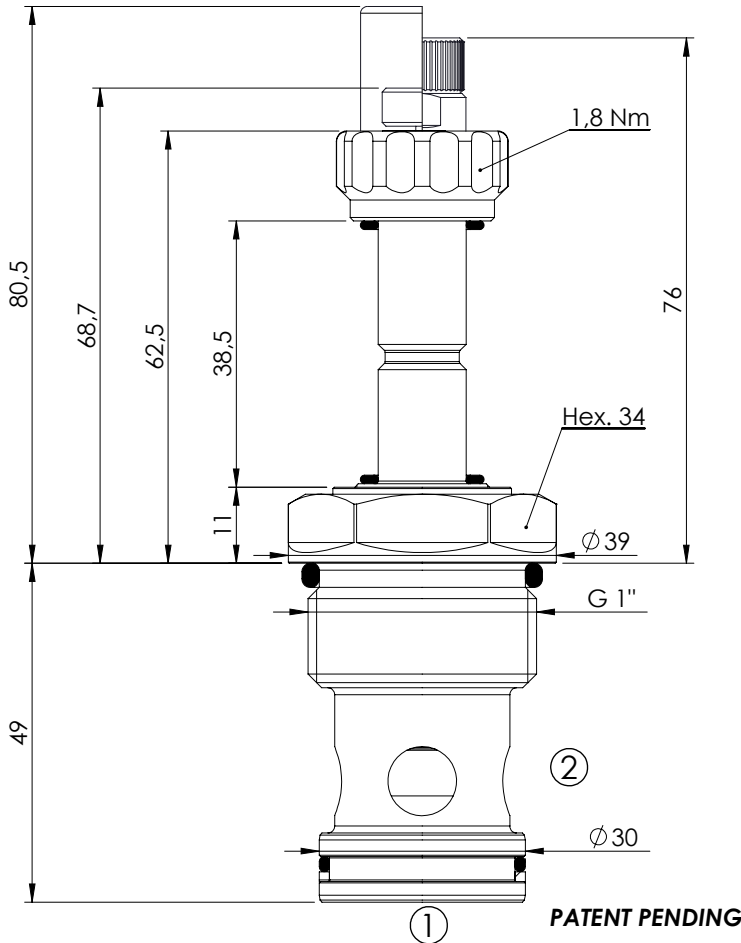

**SPECIFICATIONS**

Max. operating pressure:	350/500 bar
Rated flow:	200 l/min
Cavity:	VP000013
Weight:	0,35 kg
Min. voltage required:	90% of nominal
Coil type:	M7 type
Seal kit:	RC900013

**NOTES**

Installation torque: 135 - 150 Nm

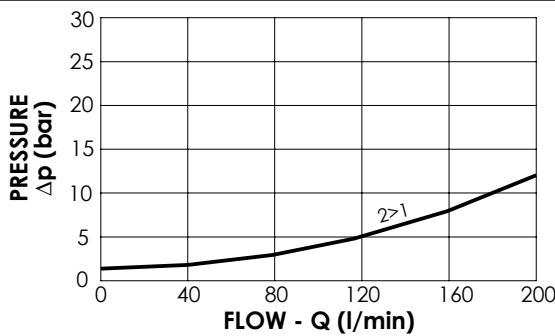

**OPTIONS**

- Standard
- Push style override
- Knob style override

**SEALING CAP**

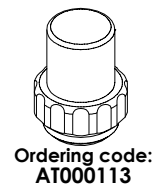

**ORDERING CODES**

Quick code	Description	Options	Max operating pressure (bar)
CE000370	CEBN-200-NAFN-02-013-N350	Standard	350
CE000371	CEBN-200-NAFP-02-013-N350	Push style override	350
CE000372	CEBN-200-NAFK-02-013-N350	Knob style override	350
CE000670	CEBN-200-NAFN-02-013-N500	Standard	500
CE000671	CEBN-200-NAFP-02-013-N500	Push style override	500
CE000672	CEBN-200-NAFK-02-013-N500	Knob style override	500