

SOLENOID OPERATED CARTRIDGE

CEBN-070-NAFN

**PILOT OPERATED
POPPET TYPE**

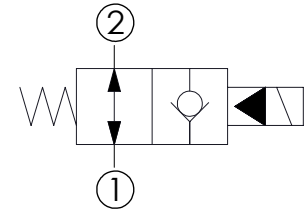
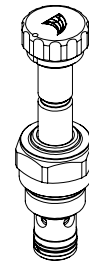
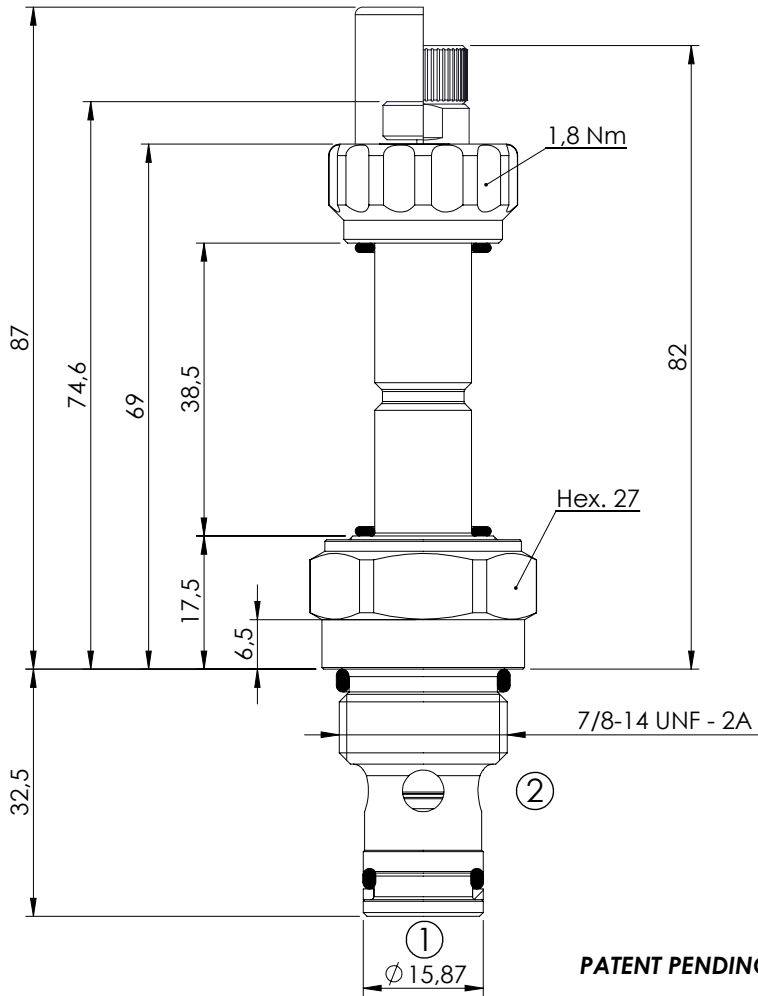

SPECIFICATIONS



| | |
|--------------------------|----------------|
| Max. operating pressure: | 350/500 bar |
| Rated flow: | 70 l/min |
| Cavity: | SAE-10-2N |
| Weight: | 0,18 kg |
| Min. voltage required: | 90% of nominal |
| Coil type: | M7 type |
| Seal kit: | RA900082 |

NOTES

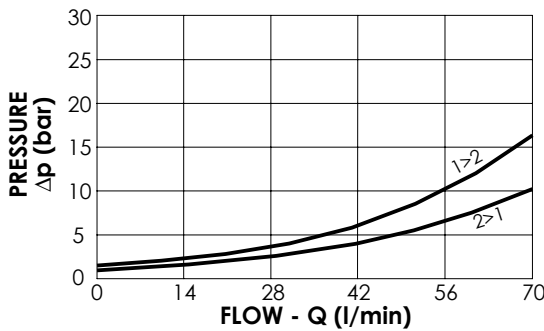
Installation torque: 55 - 62 Nm



OPTIONS

-  Standard
-  Push style override
-  Knob style override

SEALING CAP

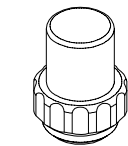

Ordering code:
AT000113

ORDERING CODES

| Quick code | Description | Options | Max operating pressure (bar) |
|------------|---------------------------|---------------------|------------------------------|
| CE000271 | CEBN-070-NAFN-06-S10-N350 | Standard | 350 |
| CE000272 | CEBN-070-NAFP-06-S10-N350 | Push style override | 350 |
| CE000273 | CEBN-070-NAFK-06-S10-N350 | Knob style override | 350 |
| CE000571 | CEBN-070-NAFN-06-S10-N500 | Standard | 500 |
| CE000572 | CEBN-070-NAFP-06-S10-N500 | Push style override | 500 |
| CE000573 | CEBN-070-NAFK-06-S10-N500 | Knob style override | 500 |