

SOLENOID OPERATED CARTRIDGE

CEBN-040-NAFN

**PILOT OPERATED
POPPET TYPE**

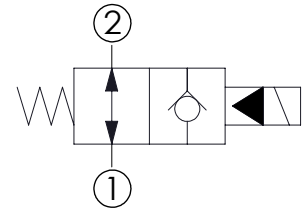
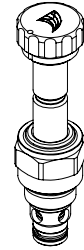
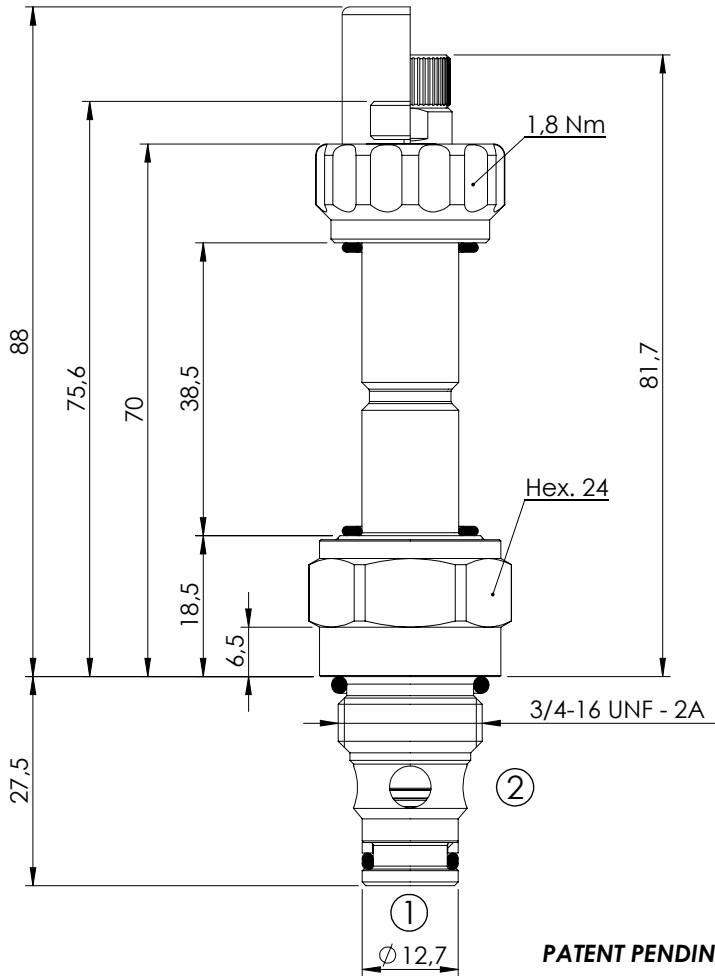

SPECIFICATIONS

Max. operating pressure:	350/500 bar
Rated flow:	40 l/min
Cavity:	SAE-08-2N
Weight:	0,14 kg
Min. voltage required:	90% of nominal
Coil type:	M7 type
Seal kit:	RA900081

NOTES

Installation torque: 45 - 50 Nm

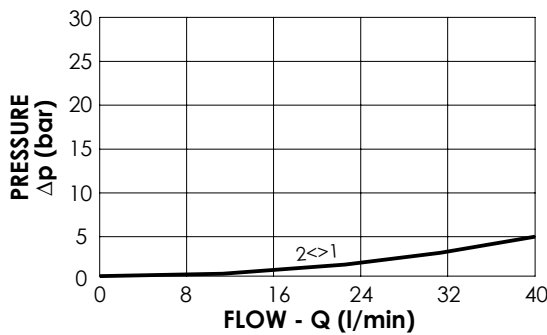

OPTIONS

- Standard
- Push style override
- Knob style override

SEALING CAP

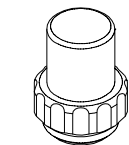

Ordering code:
AT000113

ORDERING CODES

Quick code	Description	Options	Max operating pressure (bar)
CE000233	CEBN-040-NAFN-04-S08-N350	Standard	350
CE000234	CEBN-040-NAFP-04-S08-N350	Push style override	350
CE000235	CEBN-040-NAFK-04-S08-N350	Knob style override	350
CE000533	CEBN-040-NAFN-04-S08-N500	Standard	500
CE000534	CEBN-040-NAFP-04-S08-N500	Push style override	500
CE000535	CEBN-040-NAFK-04-S08-N500	Knob style override	500