

SOLENOID OPERATED CARTRIDGE

CEBN-180-NCFN

**PILOT OPERATED
POPPET TYPE**

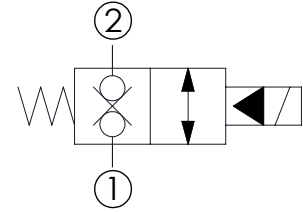
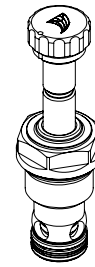
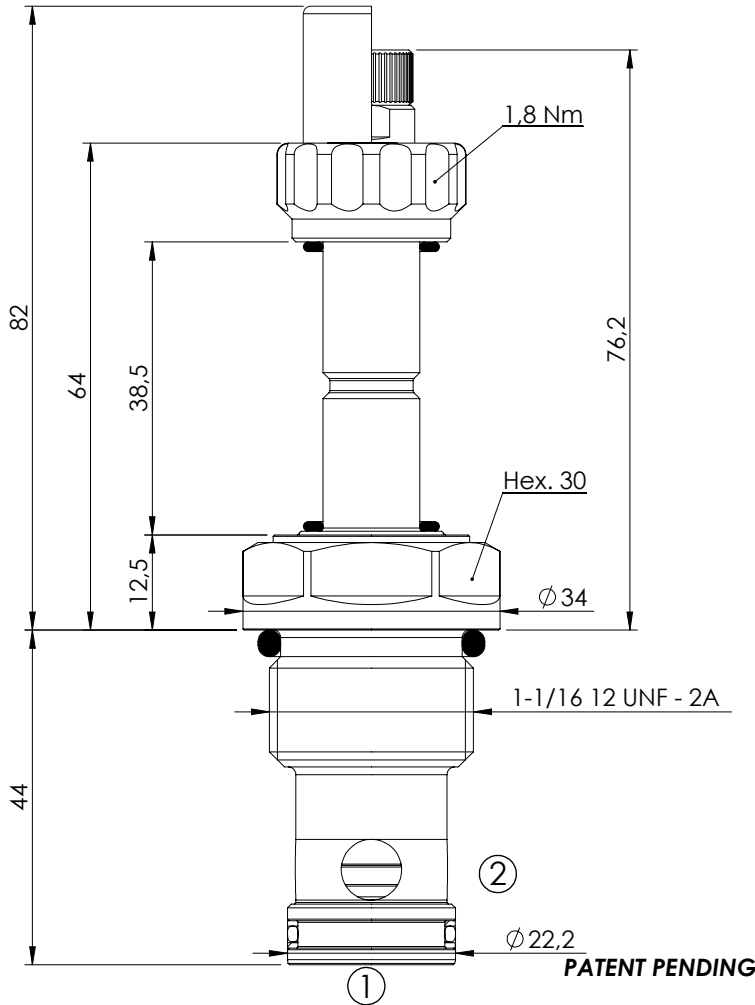

SPECIFICATIONS

Max. operating pressure:	350/500 bar
Rated flow:	180 l/min
Cavity:	SAE-12-2N
Weight:	0,25 kg
Min. voltage required:	90% of nominal
Coil type:	M7 type
Seal kit:	RB900083

NOTES

Installation torque: 135 - 150 Nm

OPTIONS

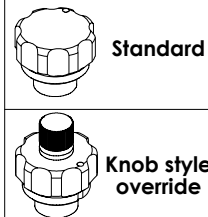

SEALING CAP

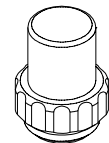

Ordering code:
AT000113

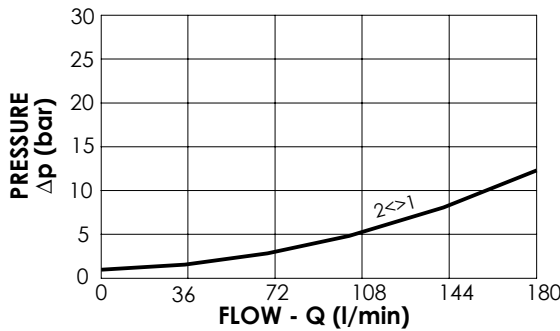

ORDERING CODES

Quick code	Description	Options	Max operating pressure (bar)
CE000331	CEBN-180-NCFN-31-S12-N350	Standard	350
CE000333	CEBN-180-NCFK-31-S12-N350	Knob style override	350
CE000631	CEBN-180-NCFN-31-S12-N500	Standard	500
CE000633	CEBN-180-NCFK-31-S12-N500	Knob style override	500