

SOLENOID OPERATED CARTRIDGE

CEBN-040-NAFN

**PILOT OPERATED
POPPET TYPE**

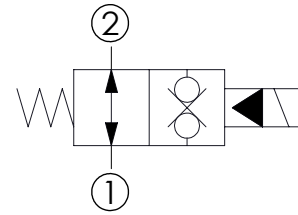
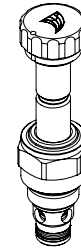
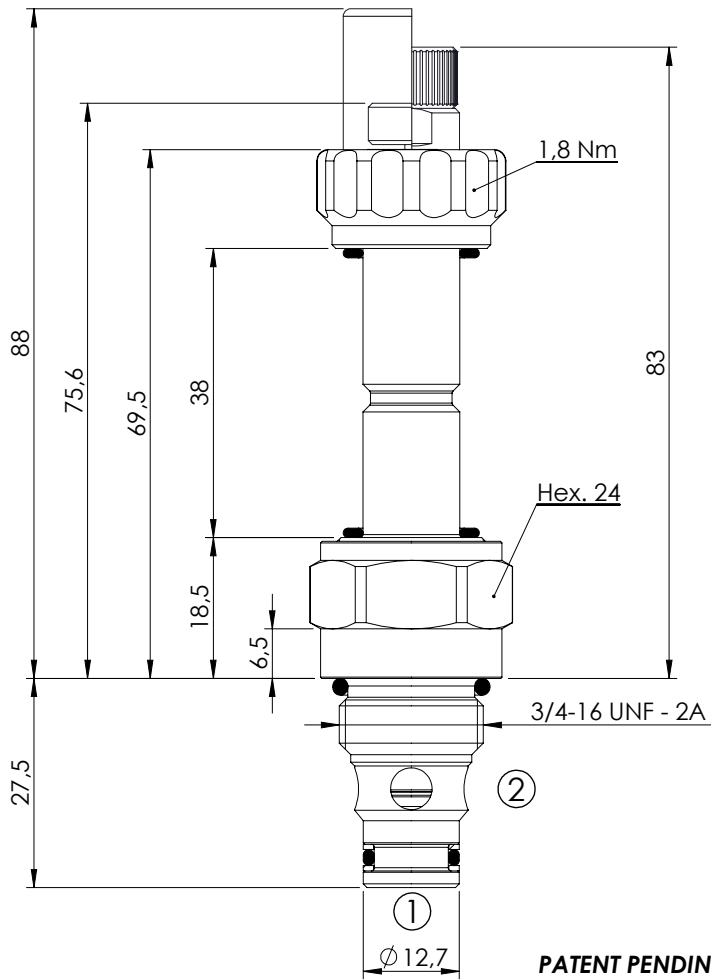

SPECIFICATIONS



| | |
|--------------------------|----------------|
| Max. operating pressure: | 350/500 bar |
| Rated flow: | 40 l/min |
| Cavity: | SAE-08-2N |
| Weight: | 0,14 kg |
| Min. voltage required: | 90% of nominal |
| Coil type: | M7 type |
| Seal kit: | RB900081 |

NOTES

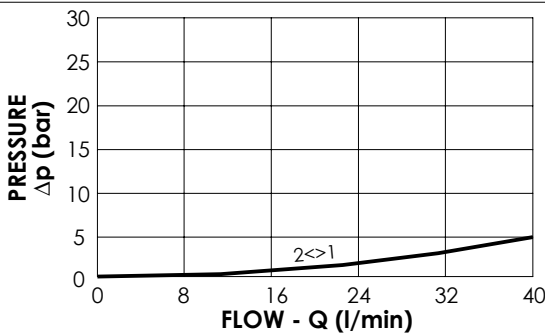
Installation torque: 45 - 50 Nm



OPTIONS

-  Standard
-  Push style override
-  Knob style override

SEALING CAP

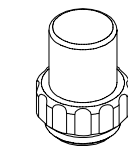

Ordering code:
AT000113

ORDERING CODES

| Quick code | Description | Options | Max operating pressure (bar) |
|------------|---------------------------|---------------------|------------------------------|
| CE000242 | CEBN-040-NAFN-32-S08-N350 | Standard | 350 |
| CE000243 | CEBN-040-NAFP-32-S08-N350 | Push style override | 350 |
| CE000244 | CEBN-040-NAFK-32-S08-N350 | Knob style override | 350 |
| CE000542 | CEBN-040-NAFN-32-S08-N500 | Standard | 500 |
| CE000543 | CEBN-040-NAFP-32-S08-N500 | Push style override | 500 |
| CE000544 | CEBN-040-NAFK-32-S08-N500 | Knob style override | 500 |