

**SOLENOID OPERATED CARTRIDGE**

**CEBN-180-NAFN**

**PILOT OPERATED  
POPPET TYPE**

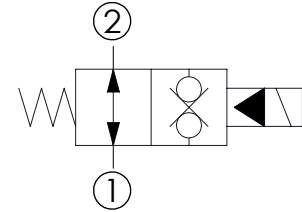

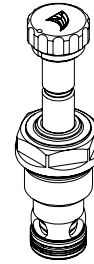
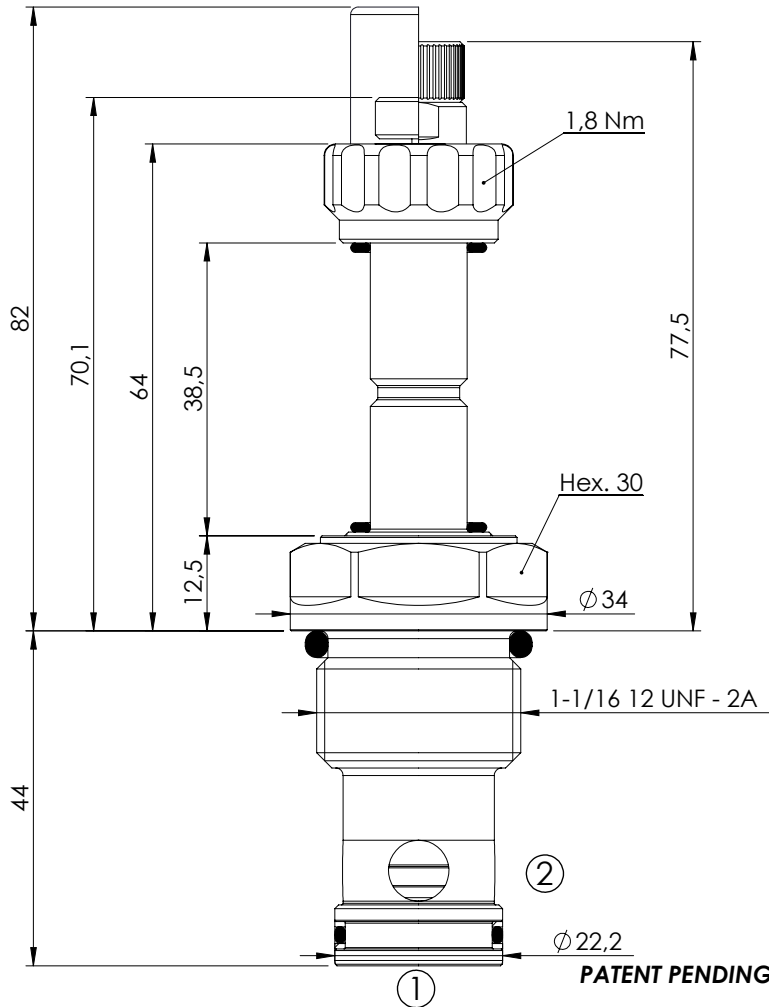

**SPECIFICATIONS**

Max. operating pressure:	350/500 bar
Rated flow:	180 l/min
Cavity:	SAE-12-2N
Weight:	0,25 kg
Min. voltage required:	90% of nominal
Coil type:	M7 type
Seal kit:	RB900083

**NOTES**

Installation torque: 135 - 150 Nm

**OPTIONS**

-  Standard
-  Push style override
-  Knob style override

**SEALING CAP**

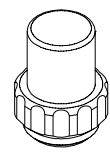

Ordering code:  
AT000113

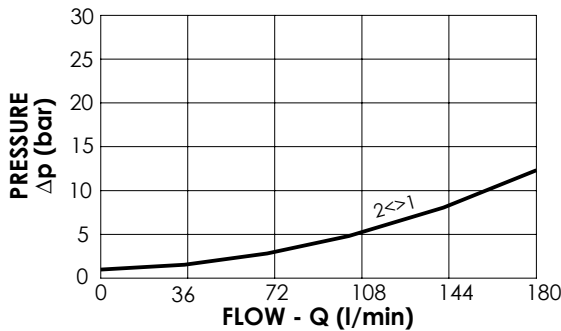

**ORDERING CODES**

Quick code	Description	Options	Max operating pressure (bar)
CE000347	CEBN-180-NAFN-32-S12-N350	Standard	350
CE000348	CEBN-180-NAFP-32-S12-N350	Push style override	350
CE000349	CEBN-180-NAFK-32-S12-N350	Knob style override	350
CE000647	CEBN-180-NAFN-32-S12-N500	Standard	500
CE000648	CEBN-180-NAFP-32-S12-N500	Push style override	500
CE000649	CEBN-180-NAFK-32-S12-N500	Knob style override	500