

SOLENOID OPERATED CARTRIDGE

CECT-080-PRPS

**PROPORTIONAL VALVES
PILOTED OPERATED PRESSURE
REDUCING AND RELIEVING**

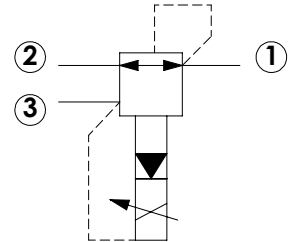
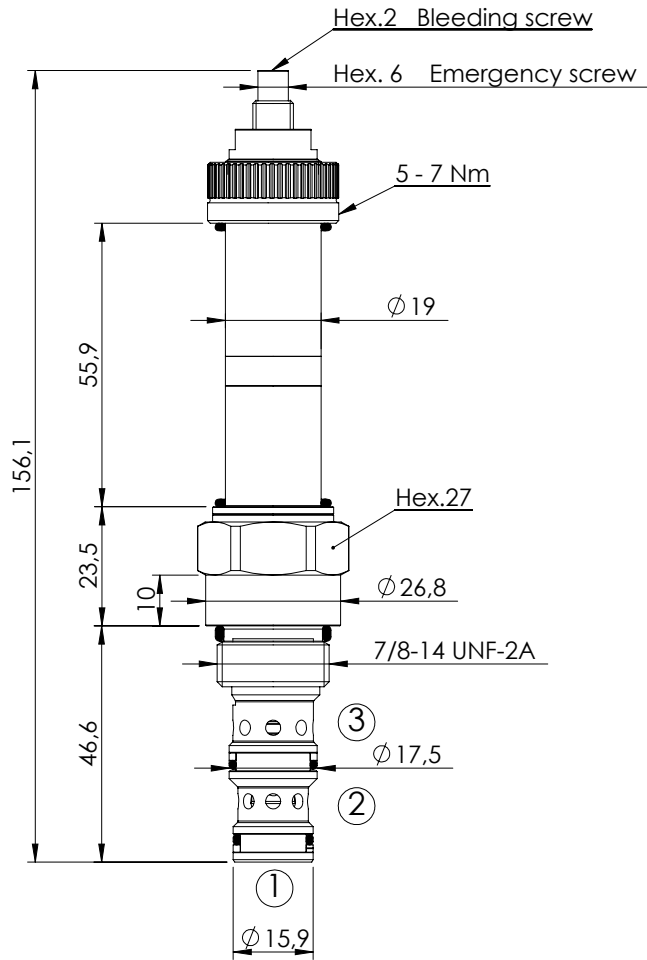

SPECIFICATIONS

Max. operating pressure:	250 bar
Rated flow:	80 l/min
Cavity:	SAE-10-3N
Weight:	0,22 kg
Coil type:	M15 type
Installation torque:	50 - 57 Nm
PWM range recommended:	120-150 Hz
Seal kit:	RA100092

NOTES

Bleed air before use

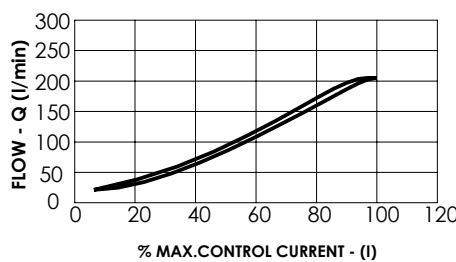
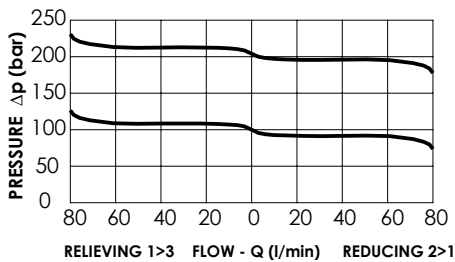

ORDERING CODES

Quick code	Description	Regulated pressure range (bar)	Threshold current (with 12VDC coil)	Max control current (with 12V DC coil)	Override
CE000122	CECT-080-PRPS-96-S10-V210	20-220	200 mA (+/-7%)	1700 mA (+/-7%)	Screw style