

SOLENOID OPERATED CARTRIDGE

CEBT-300-PLPS

**PROPORTIONAL VALVES
PILOTED RELIEF
SPOOL TYPE**

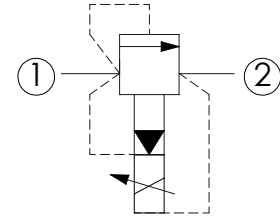
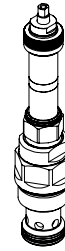
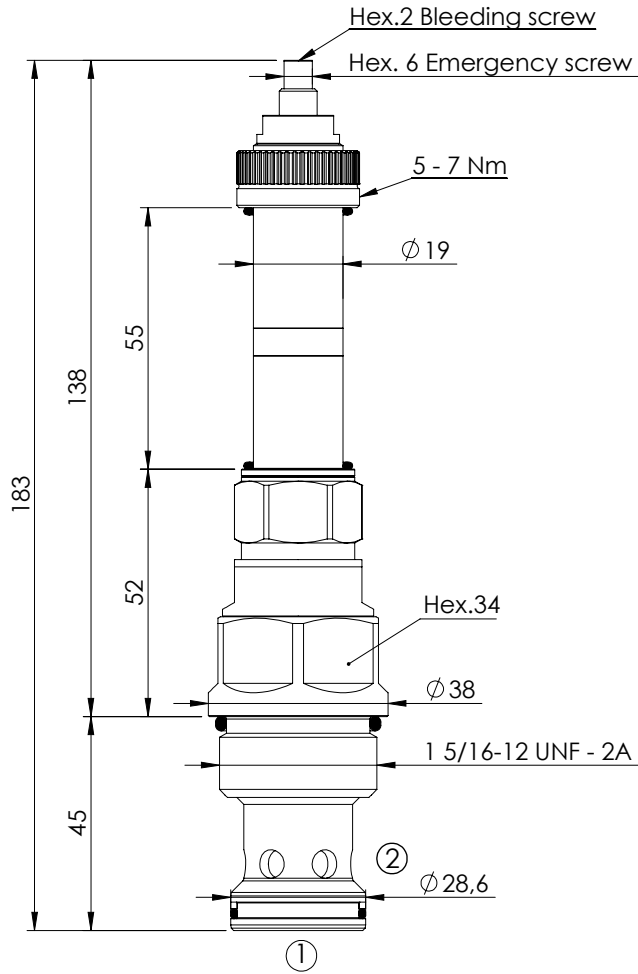

SPECIFICATIONS

Max. operating pressure:	350 bar
Rated flow:	300 l/min
Cavity:	SAE-16-2N
Weight:	0,5 kg
Coil type:	M15 type
Max. int. leakage:	200 cm ³ /min (@46 cSt)
Installation torque:	110 - 120 Nm
PWM range recommended:	150-180 Hz
Seal kit:	RA100084

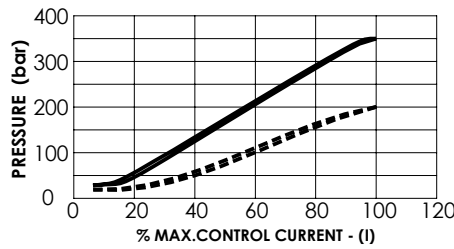
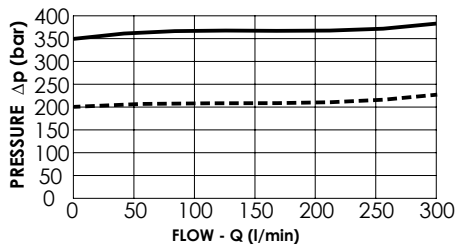

CE000880 1>2 ————— CE000895 1>2 - - - - -

NOTES

Bleed air before use

ORDERING CODES

Quick code	Description	Proportional setting range (bar)	Threshold current (with 12VDC coil)	Max control current (with 12V DC coil)	Override
CE000880	CEBT-300-PLPS-91-S16-V350	30-350	200 mA (+/-7%)	1600 mA (+/-7%)	Screw style
CE000895	CEBT-300-PLPS-91-S16-V200	20-200	200 mA (+/-7%)	1700 mA (+/-7%)	Screw style