

SOLENOID OPERATED CARTRIDGE

CEBN-200-NAFN

**PILOT OPERATED
POPPET TYPE**

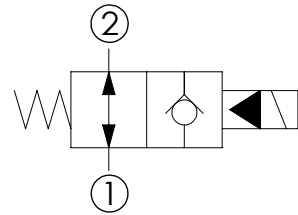
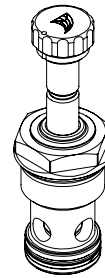
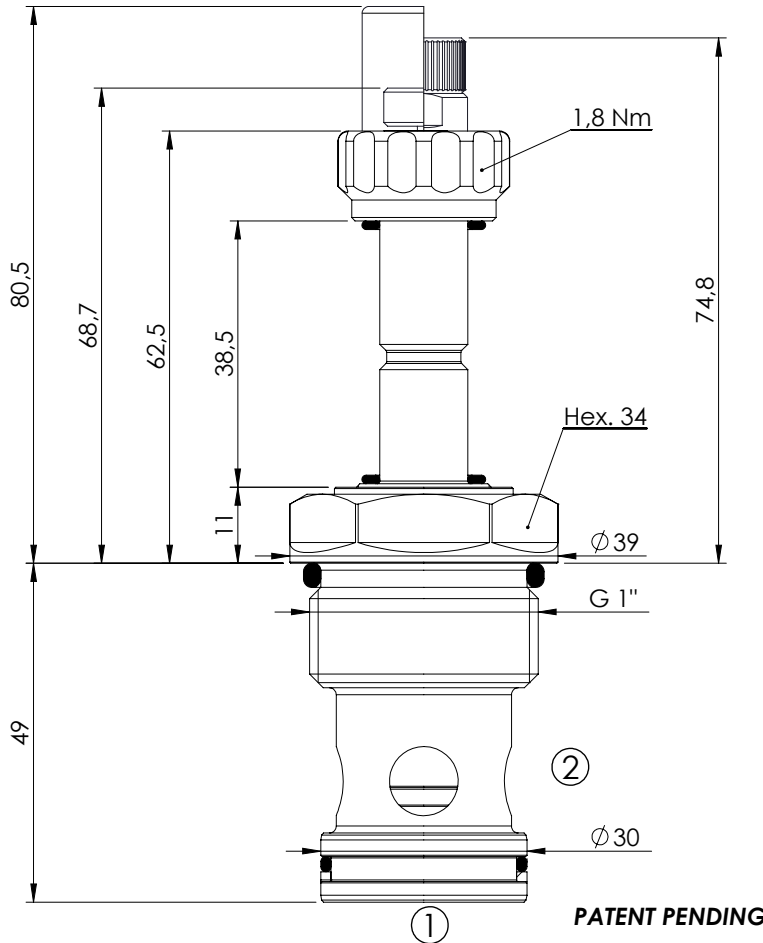

SPECIFICATIONS

Max. operating pressure:	350/500 bar
Rated flow:	200 l/min
Cavity:	VP000013
Weight:	0,35 kg
Min. voltage required:	90% of nominal
Coil type:	M7 type
Seal kit:	RC900013

NOTES

Installation torque: 135 - 150 Nm

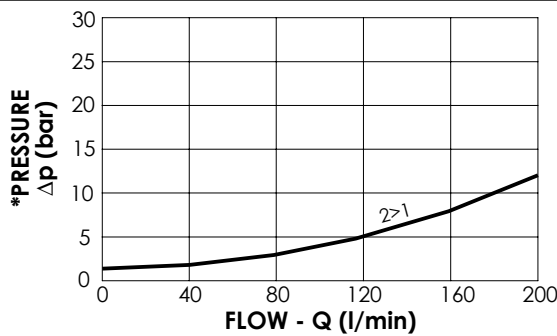

OPTIONS

- Standard
- Push style override
- Knob style override

SEALING CAP

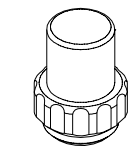

Ordering code:
AT000113

ORDERING CODES

Quick code	Description	Options	Max operating pressure (bar)
CE000373	CEBN-200-NAFN-04-013-N350	Standard	350
CE000374	CEBN-200-NAFP-04-013-N350	Push style override	350
CE000375	CEBN-200-NAFK-04-013-N350	Knob style override	350
CE000673	CEBN-200-NAFN-04-013-N500	Standard	500
CE000674	CEBN-200-NAFP-04-013-N500	Push style override	500
CE000675	CEBN-200-NAFK-04-013-N500	Knob style override	500