

CONCRETE PUMP CRANES

MBSN-060-APST

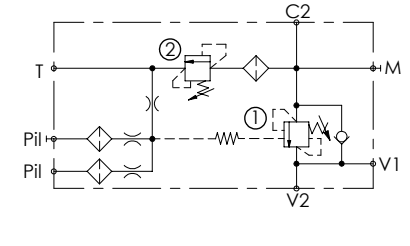
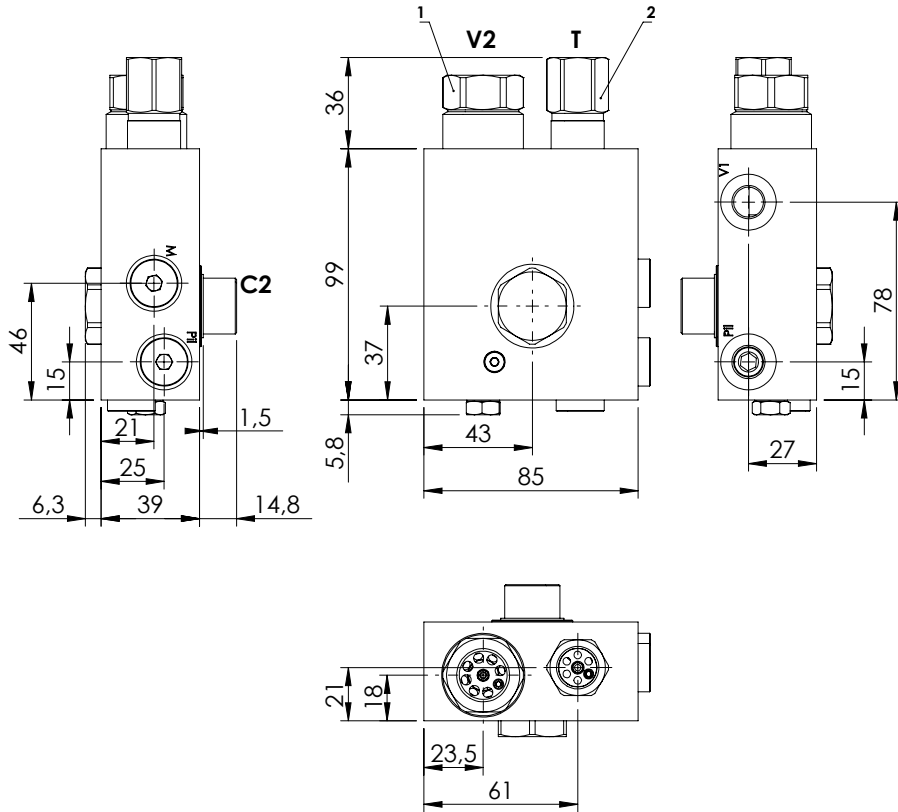
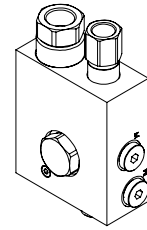

SPECIFICATIONS

Max. operating pressure:	420 bar
Rated flow:	60 l/min
Manifold:	Steel
Weight:	2,61 kg

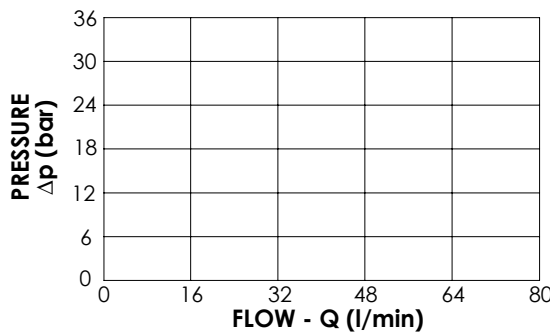

NOTES

Setting: at least 1.3 times the load induced pressure

Pilot ratio: 7:1

ORDERING CODES

Quick code	Description	Oper. pilot ratio	Main ports size	Standard setting (bar, Q=5 l/min)	Adjust. range (bar)	Pressure increase (bar/turn)
MB000823	MBSN-060-APST-07-M22-N420	1,5:1	T:G3/8" V2:G1/2" V1,M,Pil:G1/4" C2:M22x1,5	① :380 ② :400	① :200-420 ② :250-450	① :366 ② :167
MB000824	MBSN-060-APST-07-M22-N420	2,3:1	T:G3/8" V2:G1/2" V1,M,Pil:G1/4" C2:M22x1,5	① :210 ② :230	① :200-420 ② :250-450	① :366 ② :167