

EXCAVATORS VALVE

**BNND-070-AERC**

SOLENOID ACTIVATED  
FLANGED

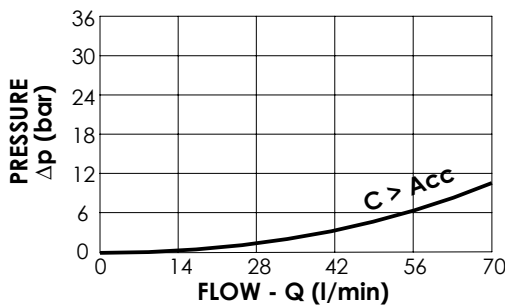
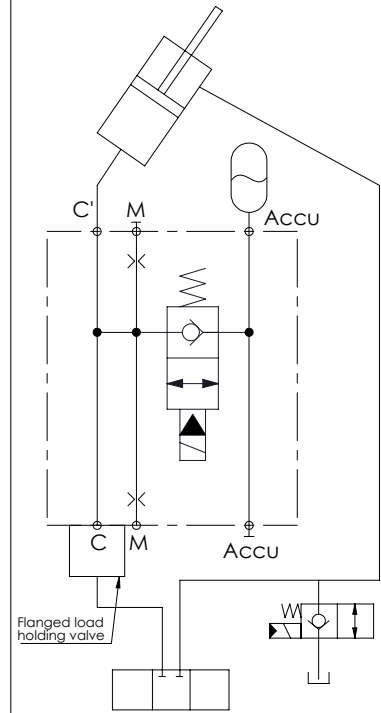
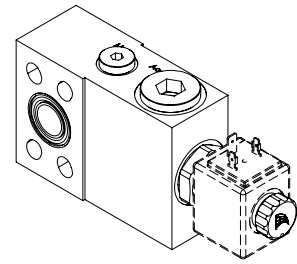
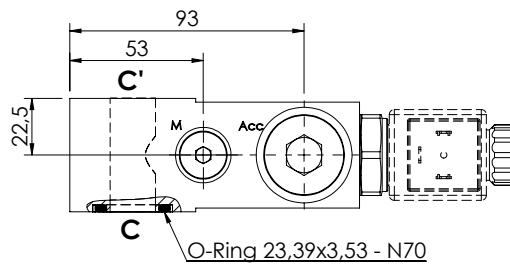
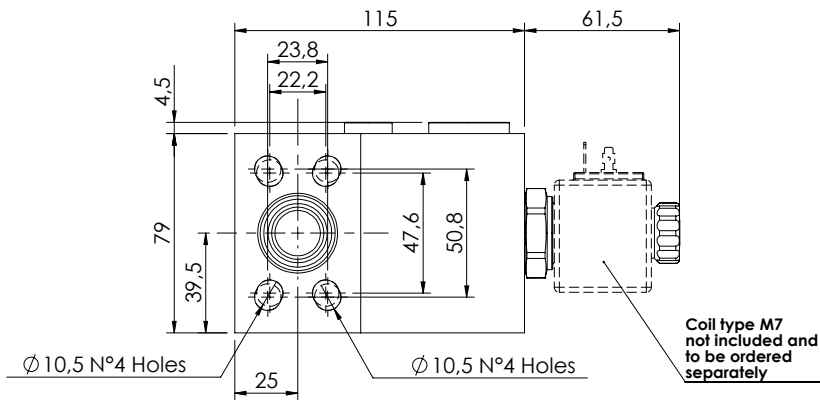
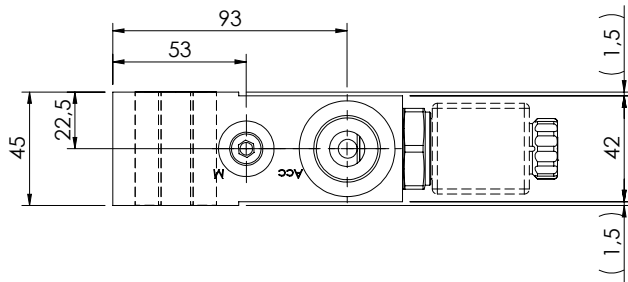

**SPECIFICATIONS**

Max. operating pressure:	420 bar
Rated flow:	70 l/min
Manifold:	Steel
Weight:	2,9 kg
Coil type:	M7

**ORDERING CODES**

Quick code	Description	Main ports size
BD000065	BNND-070-AERC-00-S34-N350	C,C': 3/4" SAE 3000/6000 Acc: G 3/4" M: G 1/4"